

# Pöydänkannet

1

Vakiovärit: pyökki, kirsikka /28 mm

vaalea koivu, pähkinä, valkoinen,  
harmaa, tammi, vaaleanharmaa  
/25 mm.

## Kansien erikoistyöt:

Suorat kannet, vakiosta pienennys

Kulman viistous

Kulman pyöristys

Mahakaari

Näppäinkolous

Päätekolous

Johtoreikä

## ■ Suorat kannet



1

## ■ Viistekannet

2

V = viistous

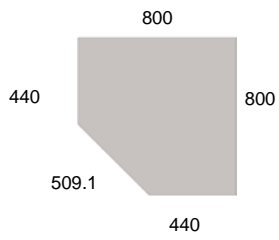

8080V

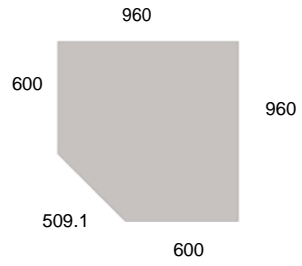

9696V

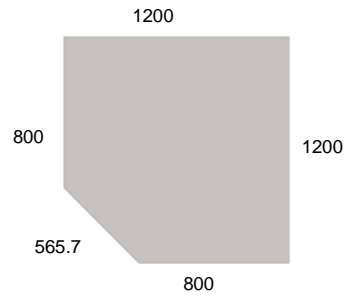

120120V

## Näppäintasot

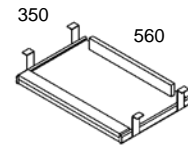

530

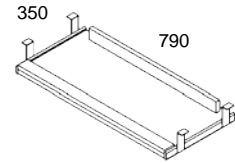

531

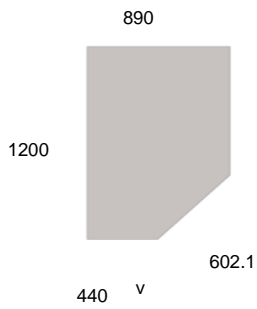

12089V v/o

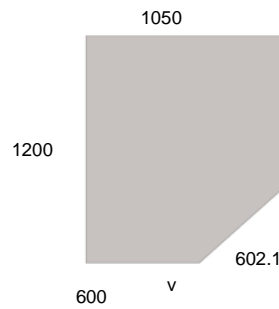

120105V v/o

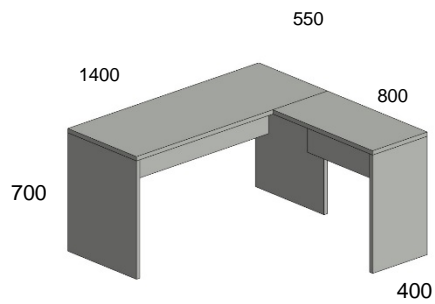
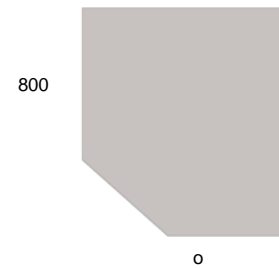

NU14055/8040

Kätisyys määritellään kokoamisvaiheessa

# ■ Mahakaarelliset kannet

3

M = mahakaari

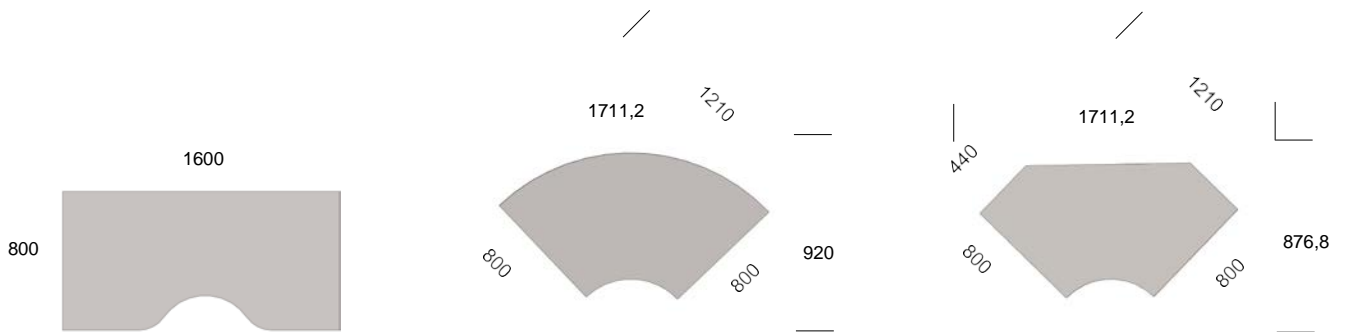

16080M

828M

829M

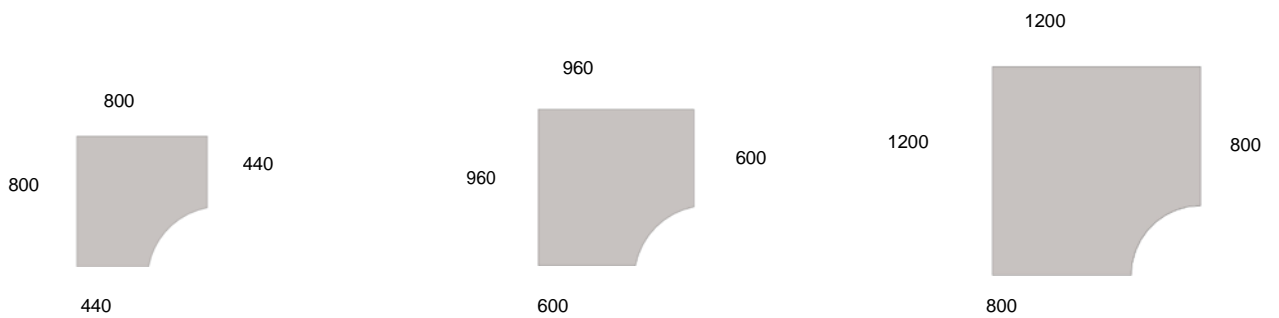

8080M

9696M

120120M

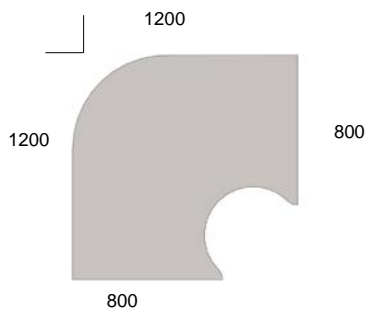

R12012080M

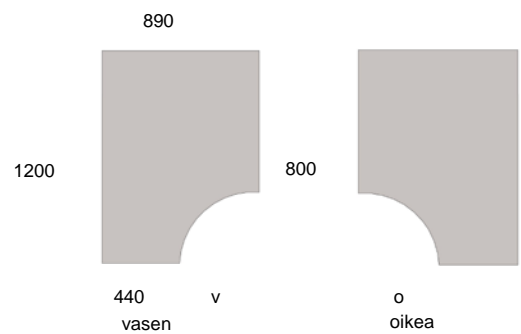

12089M v/o

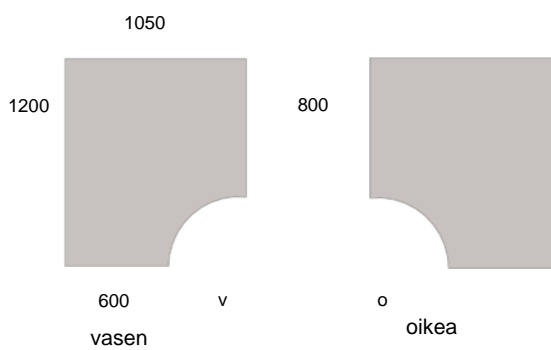

120105M v/o

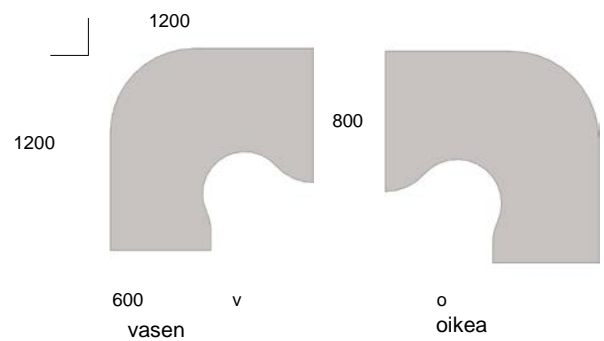

R12012060M v/o

vasen

oikea

1400-1970

4

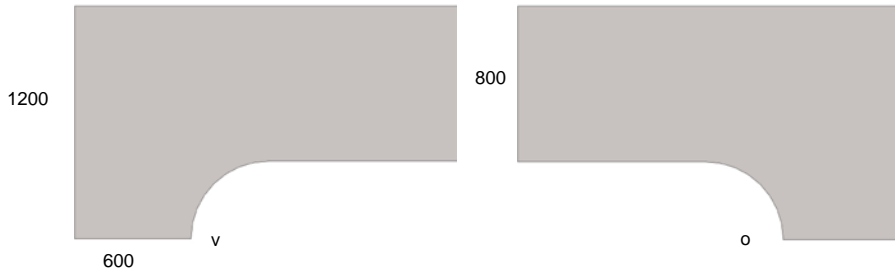

12019760M 1400-1970 v/o

1400-1970

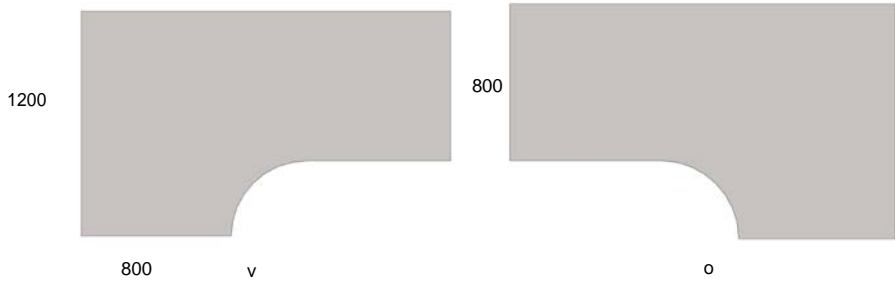

12019780M 1400-1970 v/3

1400 - 1970

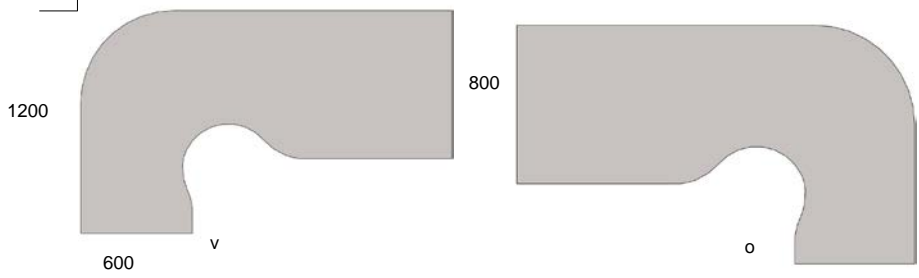

R12019760M 1400-1970 v/3

1400-1970

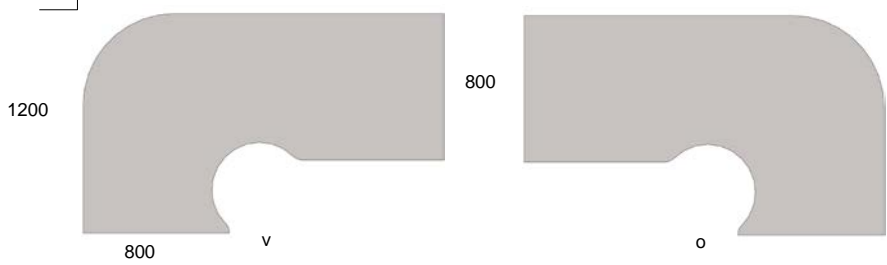

R12019780M 1400-1970 v/o

1750

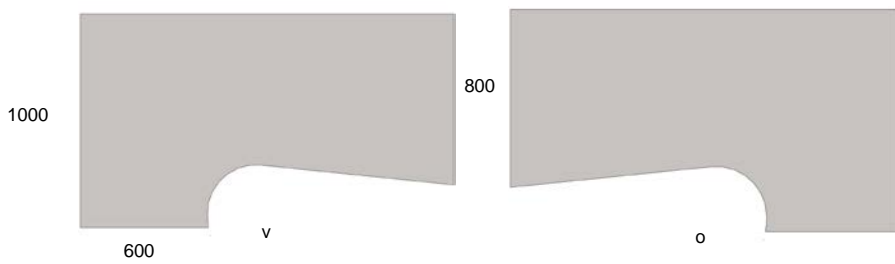

10017560M v/o

■ Muotokannet

Tynnyrikansi

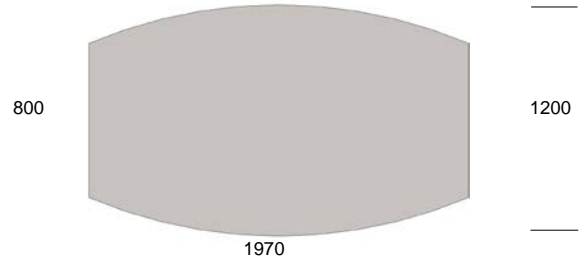

845

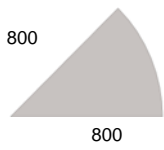

8080/45°

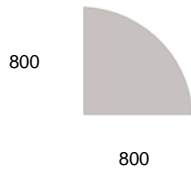

8080/90°

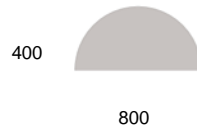

8040/180°

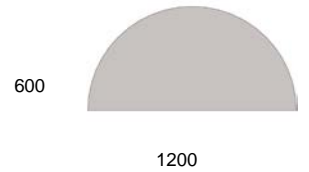

12060/180°

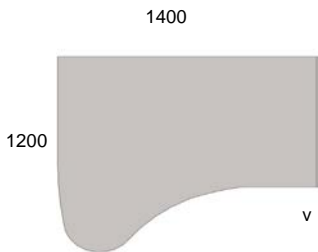

840 v/o

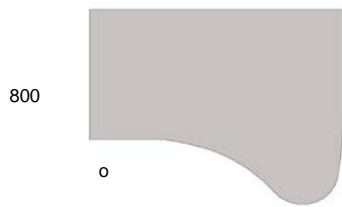

848 v/o

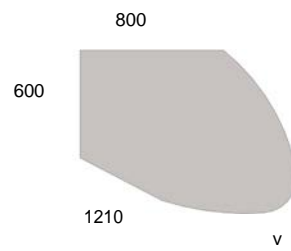

848 v/o

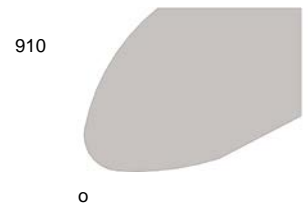

849 v/o

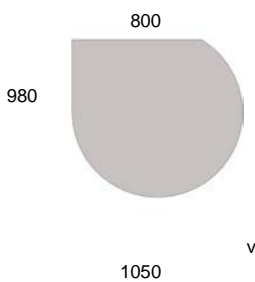

846 v/o



849 v/o

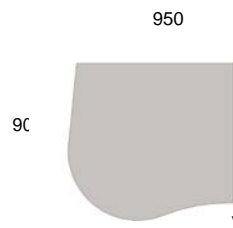

849 v/o

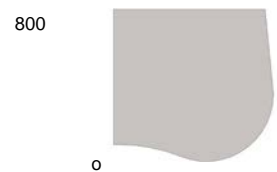

849 v/o

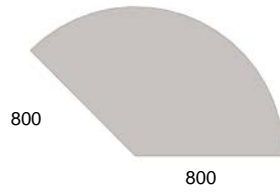

8080/135

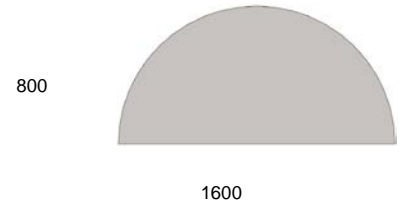

16080/180

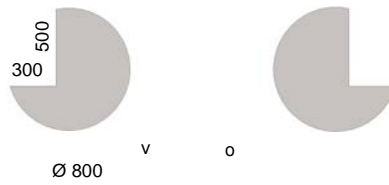

801 v/o

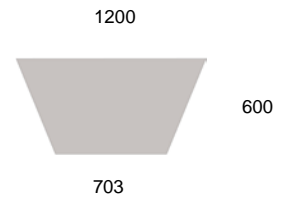

847

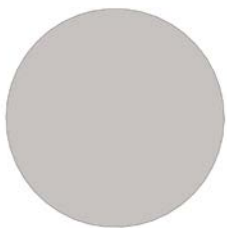

Ø 700-1200

| nr  |        |
|-----|--------|
| 70  | Ø 700  |
| 80  | Ø 800  |
| 90  | Ø 900  |
| 100 | Ø 1000 |
| 110 | Ø 1100 |
| 120 | Ø 1200 |

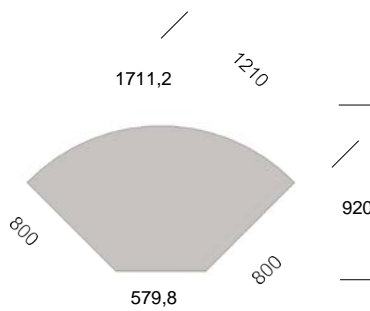

828V

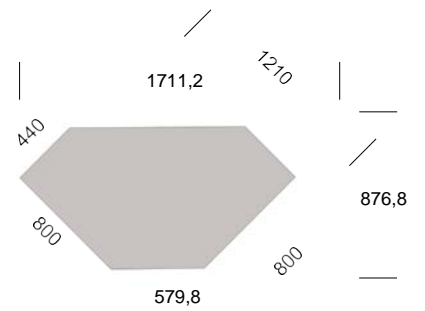

829V

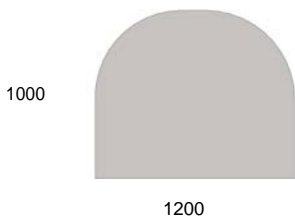

1201000V



116850V

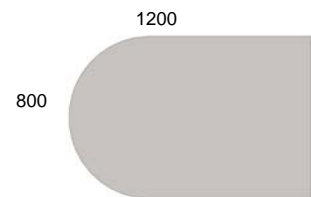

813

**Huom!** Muotopalvelutiskin alle tuleva pöydänkansi sisältyy palvelutiskin hintaan. Suoriin tiskeihin kansi ei sisälly, vaan ne tilataan erikseen. Etulevyjen hintaan sisältyvät kiinnityskulmat.

Vakiovärit: pyökki, kirsikka, vaalea koivu, pähkinä, valkoinen, harmaa, tammi, vaaleanharmaa.

TI = palvelutiski

E = etulevy

EPP = etulevy potkupellillä

EME = etulevy metalli

## Etulevy Rei'itetty metalli

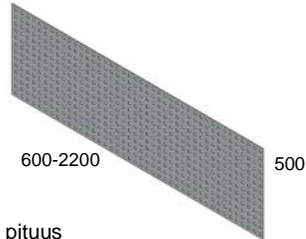

nr = pituus

60EME-120EME

121EME-170EME

171EME-220EME

## Etulevy kulmaan

Rei'itetty metalli.



nr

732EME

## Palvelutiski

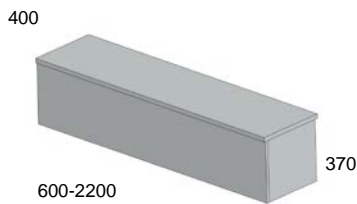

nr = pituus

60TI-120TI

121TI-170TI

171TI-220TI

## Etulevy

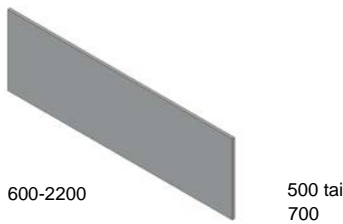

nr = pituus

60E-120E

121E-170E

171E-220E

Kolous

## Etulevy potkupellillä

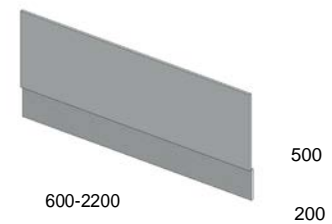

nr = pituus

60EPP-120EPP

121EPP-170EPP

171EPP-220EPP

Kolous

## Palvelutiski



732TI

Sisältää muotokannen nr 8080/90°

## Etulevy



732E

Sopii muotokanteen nr 8080/90°

## Etulevy potkupellillä



732EPP

Sopii muotokanteen nr 8080/90°

## Palvelutiski



828TI

Sisältää muotokannen nr 828M

## Etulevy



828E

Sopii muotokanteen nr 828M

## Etulevy potkupellillä



828EPP

Sopii muotokanteen nr 828M



730

TI730S

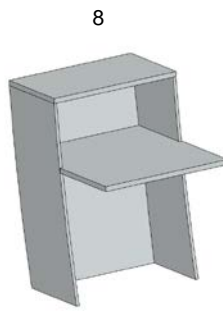

1100

8

TI1100S



730

TI730M

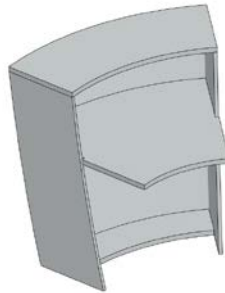

1100

TI1100M

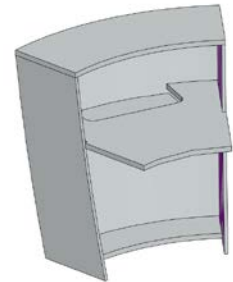

1100

TI1100MP

## Tilanjakajat

Vakiovärit: pyökki, kirsikka, vaalea koivu, pähkinä, valkoinen, harmaa, tammi, vaaleanharmaa. Tilanjakajan hintaan sisältyy kaksi sermin jalkaa ja kaksi sermin päätulistaa.

Lisävarusteena tilanjakajiin on saatavissa ääntä vaimentavat pehmusteet. Pehmusteen materiaali: Halltex-levy + kangasverhoilu.

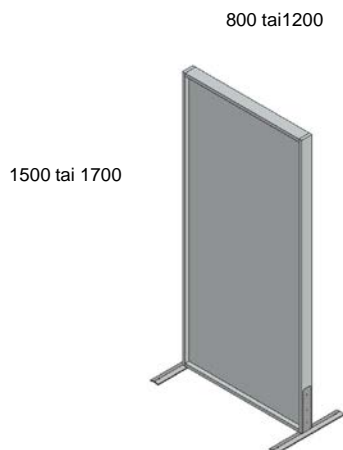

800 tai 1200

1500 tai 1700

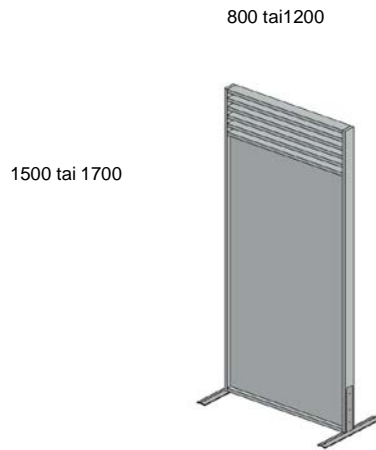

800 tai 1200

1500 tai 1700

### ■ Lisävaruste

#### Tilanjakajan pehmusteet

Värvaihtoehdot:

- vaalea harmaa
- beige
- sininen
- vaalea vihreä

| nr  |           |
|-----|-----------|
| 999 | 1500x800  |
| 999 | 1700x800  |
| 999 | 1500x1200 |
| 999 | 1700x1200 |

| nr   |           |
|------|-----------|
| R999 | 1500x800  |
| R999 | 1700x800  |
| R999 | 1500x1200 |
| R999 | 1700x1200 |

| nr   |                |
|------|----------------|
| P999 | 900x800        |
| P999 | 1500-1700x800  |
| P999 | 900x1200       |
| P999 | 1500-1700x1200 |



## ■ Tuet

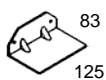

nr  
456 jalan lisätuki



nr  
458 lisäkulma

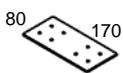

nr  
457 laattarauta

## Tuelliset tukiraudat

Tuellista tukirautaa käytetään yhdessä T-jalkojen kanssa.

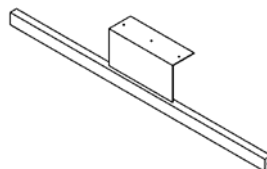

| nr    | pituus |
|-------|--------|
| 412T  | 1200   |
| 416T  | 1600   |
| 412T2 | 1200   |
| 416T2 | 1600   |

## Tukiraudat

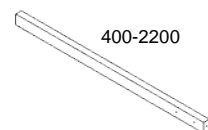

| nr  | pituus |
|-----|--------|
| 404 | 400    |
| 405 | 500    |
| 406 | 600    |
| 407 | 700    |
| 408 | 800    |
| 409 | 900    |
| 410 | 1000   |
| 411 | 1100   |
| 412 | 1200   |
| 413 | 1300   |
| 414 | 1400   |
| 415 | 1500   |
| 416 | 1600   |
| 417 | 1700   |
| 418 | 1800   |
| 419 | 1900   |
| 420 | 2000   |
| 421 | 2100   |
| 422 | 2200   |

## ■ Telineet

### Lehtiteline

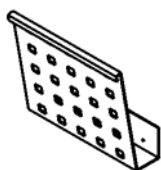

nr  
543

### Keskusyksikköteline

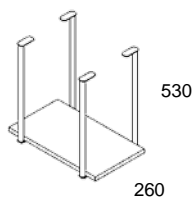

nr  
540

### Johdot järjestykseen



nr  
89 johtokouru/100 cm

## ■ Sähköcenter

Sisältää 3 kpl sähköpistoketta ja 2 kpl verkkokaapelipistoketta sekä kolouksen kanteen.

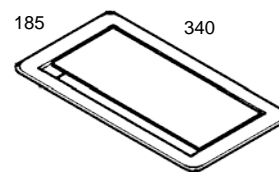

nr  
SÄHKÖC

# Työpöydän laatikostot ja -kaappi

Vakiovärit: pyökki, kirsikka, vaalea koivu, pähkinä, valkoinen, harmaa, tammi, vaaleanharmaa.

Laatikostot ja kaappi koottuna. Etusarjoissa ja kansissa 224 mm harmaa tai musta kaarivedin.

Sarjalukko vakiovarusteena malleissa 6032 ja 6042. Työpöydän laatikostojen ja kaapin alle valitaan pyörät, jalat tai sokkeli.

Laatikostojen alle:

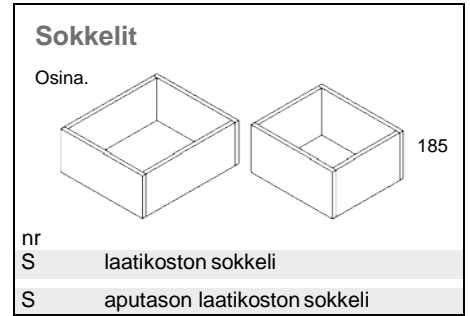
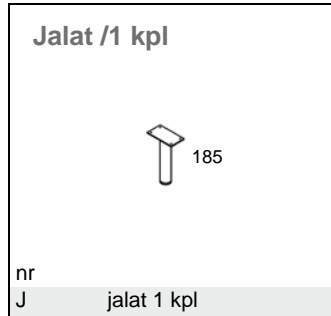
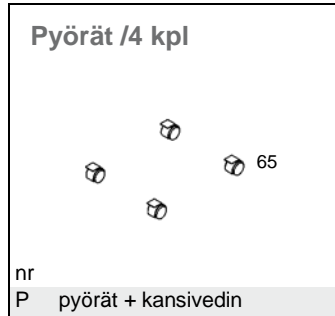

## Laatikostot metalliaihioilla

### Aputason laatikosto

Ilman lukkoa.

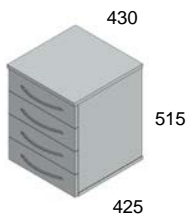

|        |               |
|--------|---------------|
| nr     |               |
| 6052   |               |
| 6052P  | pyörillä      |
| 6052J4 | 4:llä jalalla |
| 6052S  | sokkelilla    |

### Riippukansiolaatikosto

Sarjalukolla. Alin laatikko riippukansiolle.

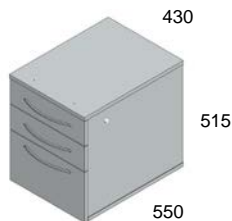

|        |               |
|--------|---------------|
| nr     |               |
| 6032   |               |
| 6032P  | pyörillä      |
| 6032J4 | 4:llä jalalla |
| 6032S  | sokkelilla    |

### 4-laatikon laatikosto

Sarjalukolla.

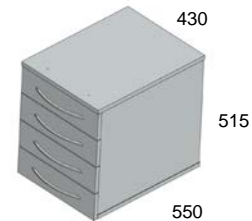

|        |               |
|--------|---------------|
| nr     |               |
| 6042   |               |
| 6042P  | pyörillä      |
| 6042J4 | 4:llä jalalla |
| 6042S  | sokkelilla    |

## Kaappi

Lukolla.

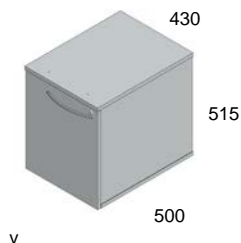

|         |                   |
|---------|-------------------|
| nr      |                   |
| 600 v/o |                   |
| 600P    | v/o pyörillä      |
| 600J4   | v/o 4:llä jalalla |
| 600S    | v/o sokkelilla    |

## Lisävarusteet

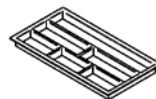

Kynäkaukalo

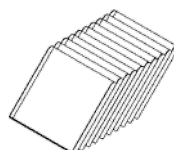

Limilokerikko 10 kpl  
Sopii riippukansiolaatikostoon 6032.

### Korotusosa

Voidaan asentaa minkä tahansa laatikoston päälle. Kuvan 4-laatikon laatikosto ei sisälly hintaan.

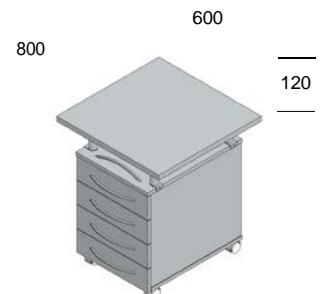

nr  
LAAKORO

# 1-osaiset hyllystöt

12

Värit: pyökki, kirsikka, valkoinen, harmaa/18 mm.

Taustat: yksipuolinen hyllynvärinen MDF 4 mm.

Mappihyllystöjen ovissa lukot ja 224 mm kaarivedin, musta tai harmaa. Kiinteän sokkelin korkeus 100 mm. Toimitetaan osina.

## Mappihyllyt

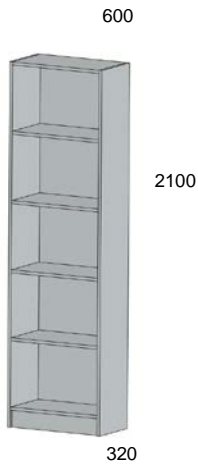

nr  
7806

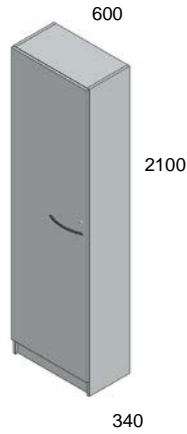

nr  
780600

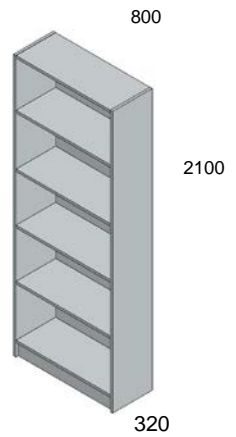

nr  
780

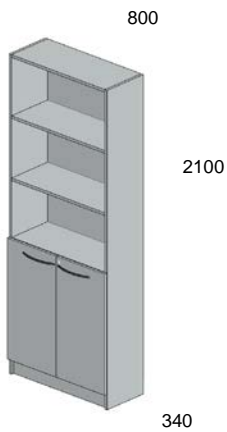

nr  
780798

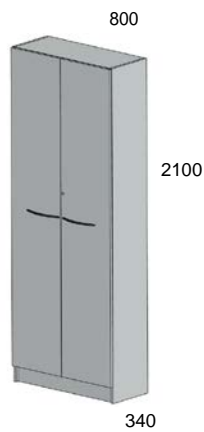

nr  
780793

## Postituskaappi

Toimitus koottuna

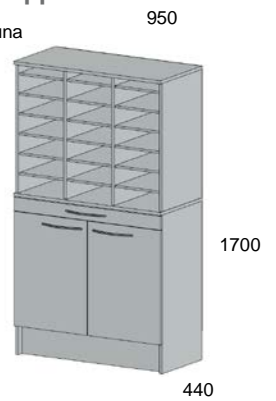

nr  
950

## Lisähyllyt

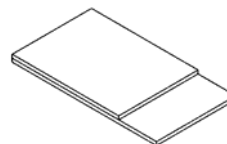

| nr     |         |   |
|--------|---------|---|
| 780HY  | 800x320 | - |
| 783HY  | 800x420 |   |
| 7806HY | 600x320 | - |
| 7806HY | 600x420 |   |

Vakiovärit: pyökki, kirsikka, vaalea koivu, pähkinä, valkoinen, harmaa, tammi, vaaleanharmaa. Rulo-ovi: pyökki, kirsikka, koivu, valkoinen.

Taustat: molemmin puolin hyllynvärinen MDF 4 mm, tammisessa ja vaaleanharmaassa joko harmaa tai valkoinen tausta. Hyllystöjä voidaan käyttää myös tilanjakajina, koska tausta on viimeistellyn näköinen.

Hyllystö toimitetaan valmiiksi koottuna korkeuksissa 100-800 mm, korkeudet 1200-2000 mm toimitetaan osina. Välihyllly on säädettävä, lukot ovat hyllystöissä vakiovaruste.

Hyllystön alle valitaan pyörät, jalat, jalustapyörät tai sokkeli.

Moduuleita voi kiinnittää päällekkäin korkeiksi hyllyköiksi, kiinnitys mukana toimitettavilla puutapeilla.

Hyllystöjen alle:

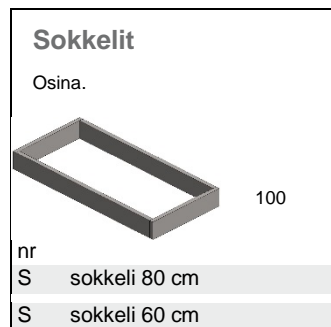
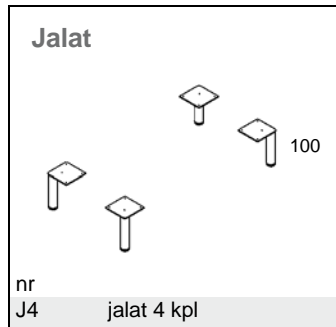
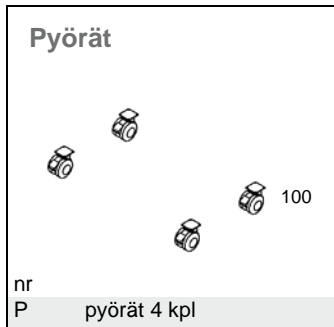

## ■ 80 cm leveät hyllystöt

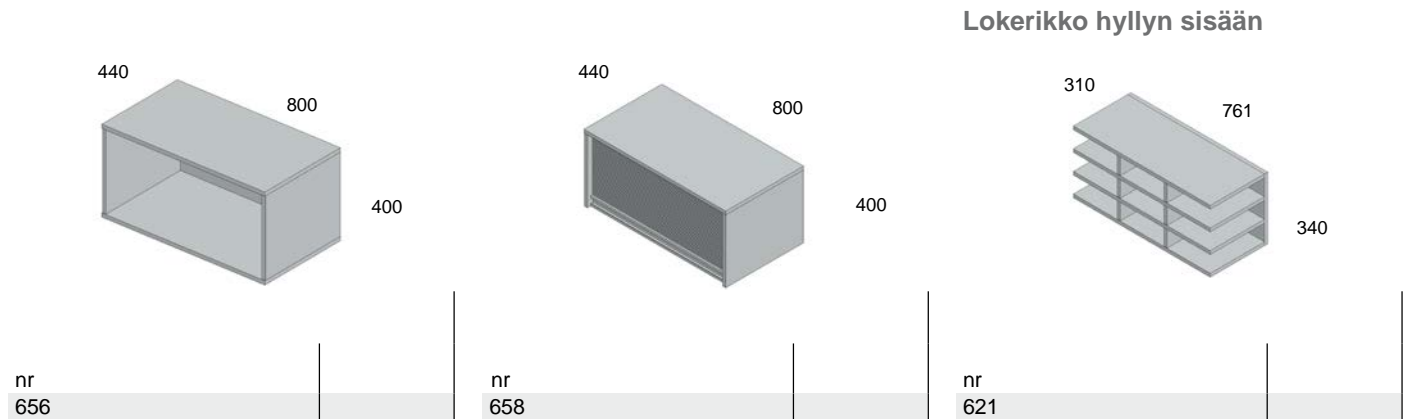

## Vetolaatikot

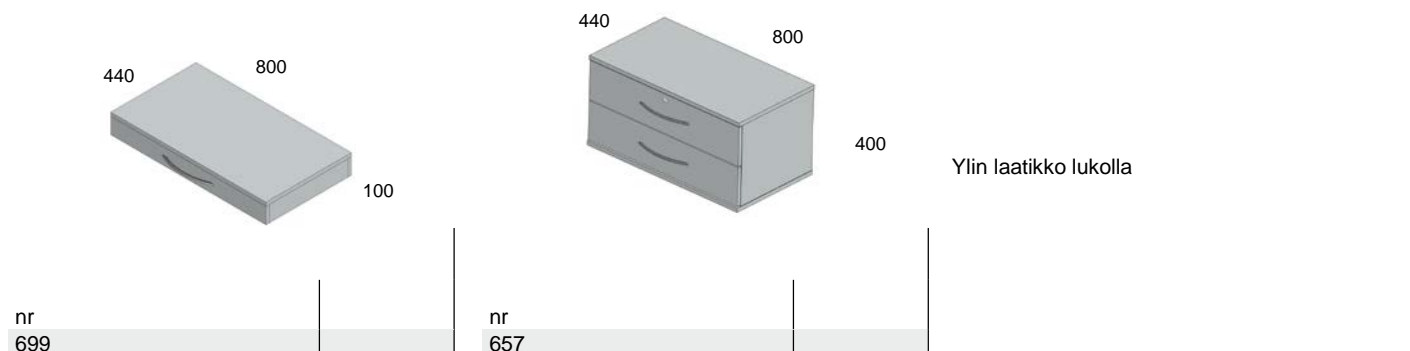

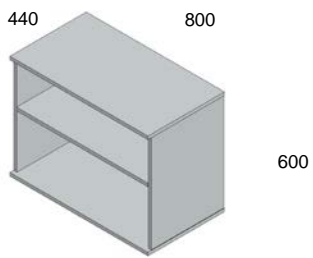

|              |  |
|--------------|--|
| nr           |  |
| 618          |  |
| 618S sokkeli |  |
| 618J4 jalat  |  |
| 618P pyörät  |  |

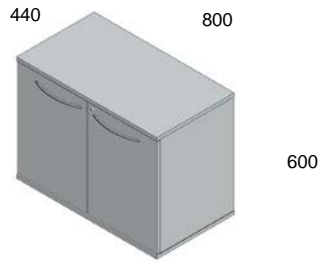

|                 |  |
|-----------------|--|
| nr              |  |
| 618674          |  |
| 618674S sokkeli |  |
| 618674J4 jalat  |  |

### Rulot

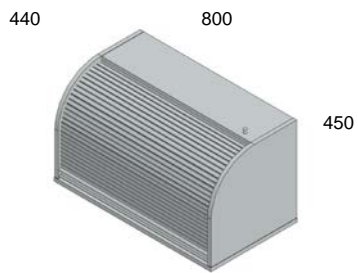

|     |  |
|-----|--|
| nr  |  |
| 625 |  |

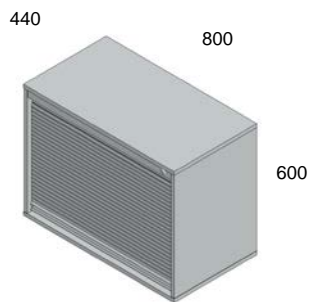

|              |  |
|--------------|--|
| nr           |  |
| 617          |  |
| 617S sokkeli |  |
| 617J4 jalat  |  |
| 617P pyörät  |  |

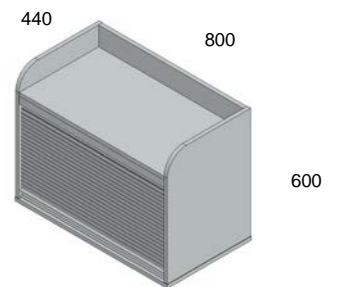

|              |  |
|--------------|--|
| nr           |  |
| 619          |  |
| 619S sokkeli |  |
| 619J4 jalat  |  |
| 619P pyörät  |  |

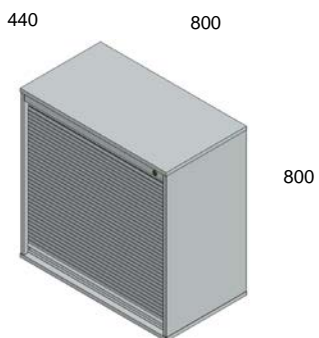

|              |  |
|--------------|--|
| nr           |  |
| 620          |  |
| 620S sokkeli |  |
| 620J4 jalat  |  |
| 620P pyörät  |  |

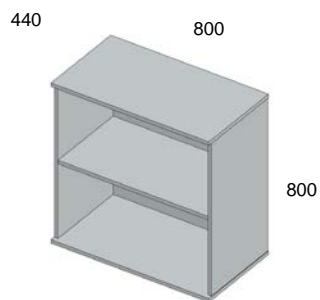

|              |  |
|--------------|--|
| nr           |  |
| 616          |  |
| 616S sokkeli |  |
| 616J4 jalat  |  |
| 616P pyörät  |  |

Liukuovet.

|              |  |
|--------------|--|
| nr           |  |
| 660          |  |
| 660S sokkeli |  |
| 660J4 jalat  |  |
| 660P pyörät  |  |

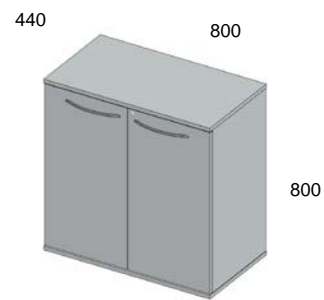

|                  |  |
|------------------|--|
| nr               |  |
| 616672           |  |
| 616672 S sokkeli |  |
| 616672J4 jalat   |  |

## Esitehyilly

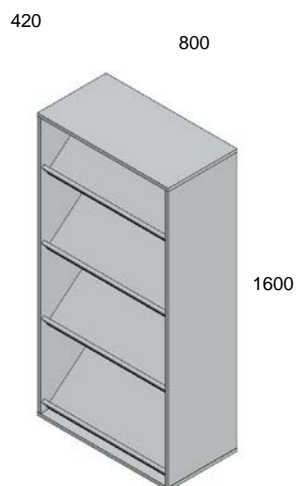

|              |  |
|--------------|--|
| nr           |  |
| 787          |  |
| 787S sokkeli |  |
| 787J4 jalat  |  |

Hyllykorkeudet  
1200-2000 mm  
toimitetaan  
osina.

## 120 cm korkeat hyllyt, sokkeli/jalat korkeus +10 cm

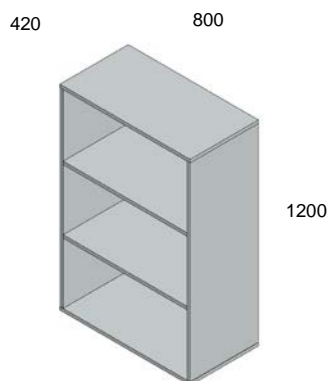

|              |  |
|--------------|--|
| nr           |  |
| 781          |  |
| 781S sokkeli |  |
| 781J4 jalat  |  |

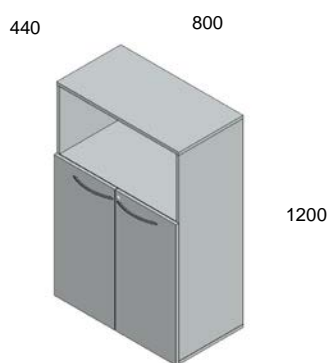

|                 |  |
|-----------------|--|
| nr              |  |
| 781798          |  |
| 781798S sokkeli |  |
| 781798J4 jalat  |  |

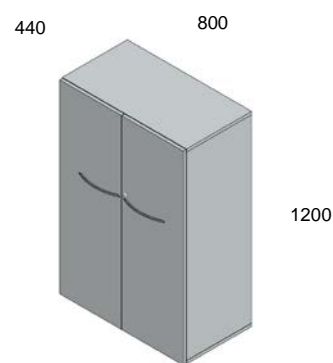

|                 |  |
|-----------------|--|
| nr              |  |
| 781784          |  |
| 781784S sokkeli |  |
| 781784J4 jalat  |  |

### Liukuovikaapit 120 cm korkeat

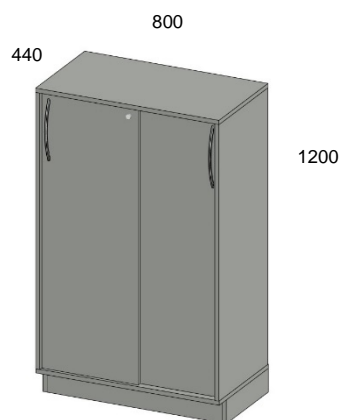

660S12080

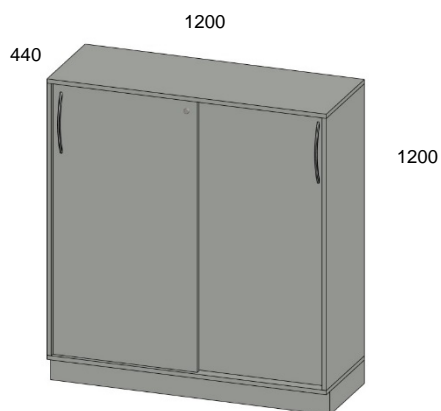

660S120120

### Apteekkarinsenkki v/o

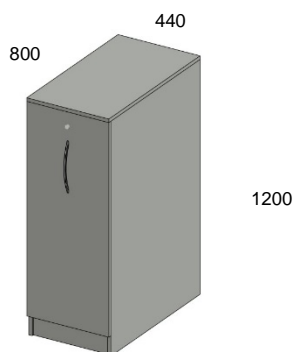

784 vasen/oikea käännetty

**160 cm korkeat hyllyt**  
sokkeli/jalat korkeus +10 cm

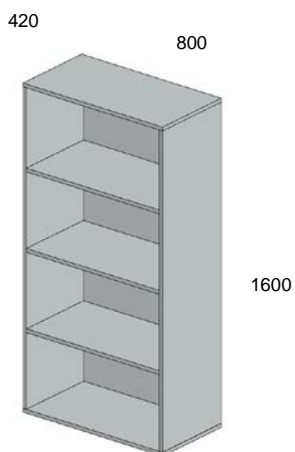

|              |  |
|--------------|--|
| nr           |  |
| 782          |  |
| 782S sokkeli |  |
| 782J4 jalat  |  |

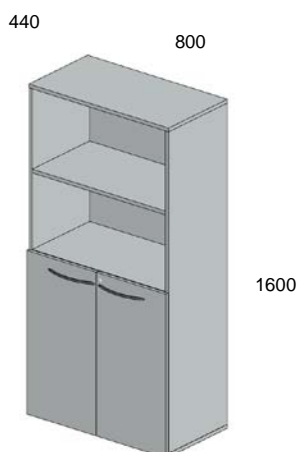

|                 |  |
|-----------------|--|
| nr              |  |
| 782798          |  |
| 782798S sokkeli |  |
| 782798J4 jalat  |  |

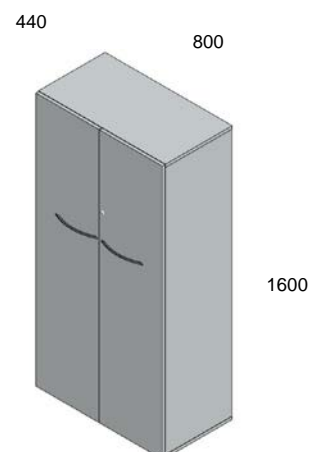

|                 |  |
|-----------------|--|
| nr              |  |
| 782786          |  |
| 782786S sokkeli |  |
| 782786J4 jalat  |  |

**200 cm korkeat hyllyt**  
sokkelin korkeus +10 cm

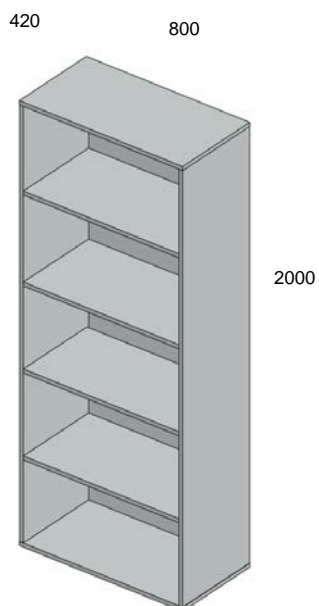

|              |  |
|--------------|--|
| nr           |  |
| 783          |  |
| 783S sokkeli |  |
| 783J4 jalat  |  |

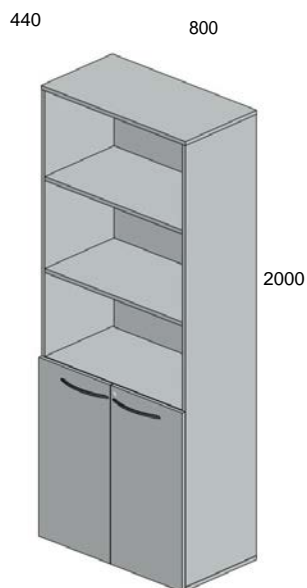

|                 |  |
|-----------------|--|
| nr              |  |
| 783798          |  |
| 783798S sokkeli |  |
| 783798J4 jalat  |  |

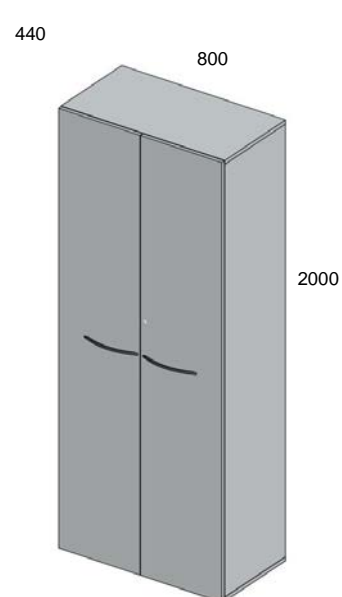

|                 |  |
|-----------------|--|
| nr              |  |
| 783793          |  |
| 783793S sokkeli |  |
| 783793J4 jalat  |  |



Vaatekaapit

Vaatekaapit sisältävät kiinteän- ja irtohyllyn, sekä ulosvedettävän henkariiu'un.

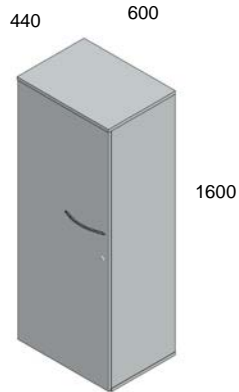
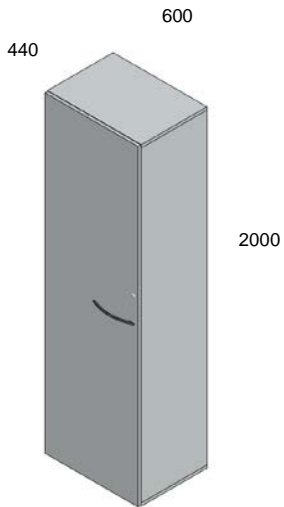

|                 |  |
|-----------------|--|
| nr              |  |
| 750600          |  |
| 750600S sokkeli |  |
| 750600J4 jalat  |  |

|                     |  |
|---------------------|--|
| nr                  |  |
| 760600 v/o          |  |
| 760600S sokkeli v/o |  |
| 760600J4 jalat v/o  |  |

60 cm leveät mappihyllyt  
sokkeli/jalat korkeus +10 cm

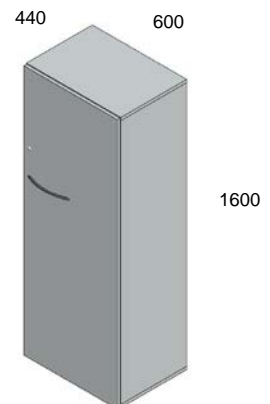
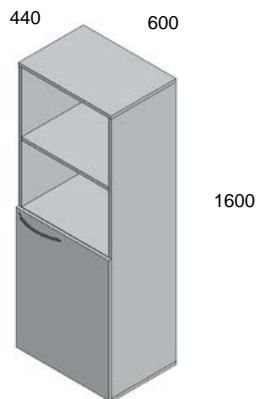
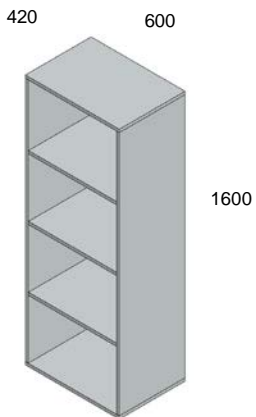

|               |  |
|---------------|--|
| nr            |  |
| 7826          |  |
| 7826S sokkeli |  |
| 7826J4 jalat  |  |

|                     |  |
|---------------------|--|
| nr                  |  |
| 782610 v/o          |  |
| 782610S sokkeli v/o |  |
| 782610J4 jalat v/o  |  |

|                     |  |
|---------------------|--|
| nr                  |  |
| 782600 v/o          |  |
| 782600S sokkeli v/o |  |
| 782600J4 jalat v/o  |  |

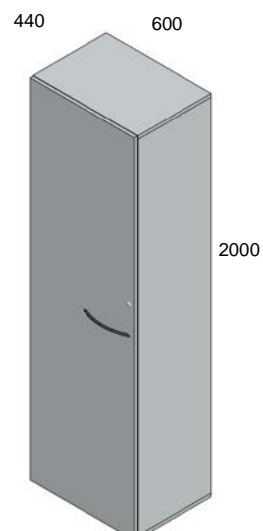
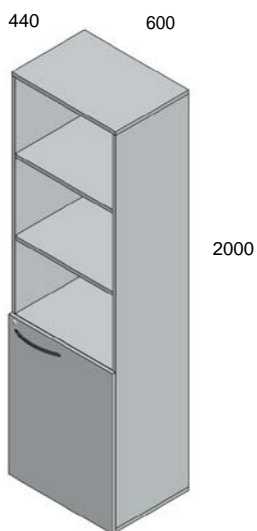
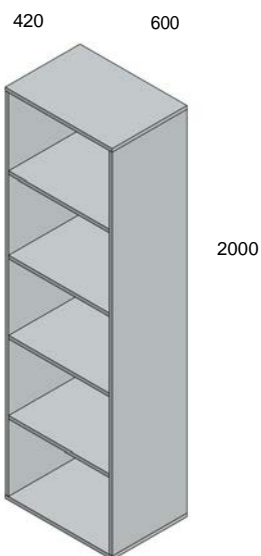

o

v

|               |  |
|---------------|--|
| nr            |  |
| 7836          |  |
| 7836S sokkeli |  |
| 7836J4 jalat  |  |

|                     |  |
|---------------------|--|
| nr                  |  |
| 783610 v/o          |  |
| 783610S sokkeli v/o |  |
| 783610J4 jalat v/o  |  |

|                 |  |
|-----------------|--|
| nr              |  |
| 783600          |  |
| 783600S sokkeli |  |
| 783600J4 jalat  |  |

## Seinähyllly ja -taulu, pöytähyllly

### Ilmoitustaulu seinälle

Alumiinikehys, kangasverhoilu.  
Verhoilukankaan värit: vaalea harmaa, beige,  
sininen, vaalea vihreä.

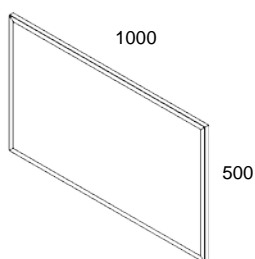

|               |  |
|---------------|--|
| nr            |  |
| Ilmoitustaulu |  |

### Pöytähyllly

Voidaan käyttää hyllystön tai pöytätason päällä.  
Jalat: metalli.

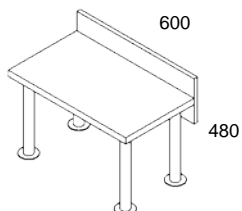

|     |  |
|-----|--|
| nr  |  |
| 655 |  |

### Seinähyllly

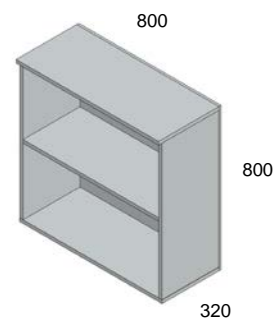

|      |             |
|------|-------------|
| nr   |             |
| S616 | seinähyllly |
| 672  | ovipari     |